

GB

RSHG

exodraft
CHIMNEY DRAFT TECHNOLOGY

- 1. GB - Product information.....3**
- 1.1 Construction and design.....3
- 1.2 Installation instructions.....4
- 1.3 Wiring7
- 1.4 Commissioning of the chimney fan.....7
- 1.5 Service and cleaning8
- 1.6 Technical specifications.....8
- 1.7 Warranty.....8
- Declaration of Conformity.....11**



1. GB - Product information

The **exodraft** Chimney Fan type RSHG is used as part of the fail-safe flue system for open flued gas appliances, such as stoves and domestic boilers. The RSHG gives a horizontal discharge of the flue gases.

Warning!



- All installations must be carried out by competent personnel in accordance with national laws and regulations



- Avoid chimney fires - ensure that the chimney has been swept before mounting the fan.
- The chimney fan must always be operating when the fireplace is in use.
- Please always read the installation instructions for the exodraft control unit, before installation of the chimney fan.

1.1 Construction and design

Construction

The body and casing are manufactured in cast aluminium, fitted with a stainless steel vane and non-moving airpressure sensors linked to a pressure differential switch (PDS), ensuring correct airflow when the fire is used. The chimney fan can be opened for service and cleaning purposes.

Main parts

The RSHG has the following main components

a	Motor housing	
b	Bottom section	
c	Motor	
d	Cooling plates	
e	Vane	
f	Safety hinge	
g	Safety net	
h	Armoured motor cable	
i	Mineral wool mat	
j	Safety wire with bolt and rawlplug	
k	Location brackets, bolts and nuts	
l	Pressure differential switch	
m	Non-moving airpressure sensors	

1.2 Installation instructions

Before fitting onto a chimney

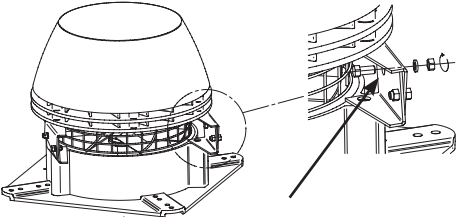
If....	then...
the fan is to be mounted onto a brick chimney	the chimney must have location brackets - see below
the fan is to be mounted onto a steel chimney	a flange is required (supplied as an extra) - see below
it is an RSHG014 remove the transport safety bolt on the hinges before mounting.	

Before fitting onto the brickwork of a chimney

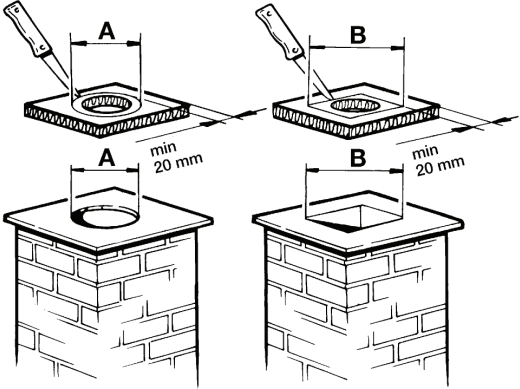
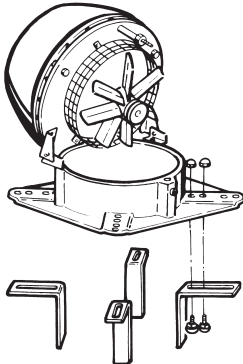
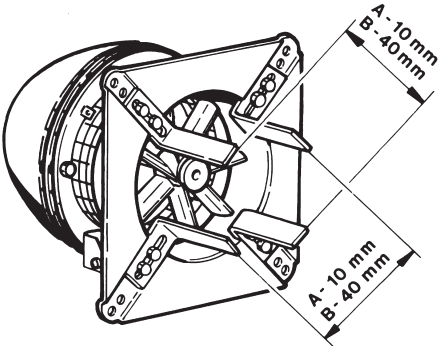
Step	Action	
1	<p>Measure the inside diameter of the chimney and cut the size of the hole in the mineral wool mat accordingly.</p> <p>Note that there must always be a minimum of 20 mm of mat surface at any point around the circumference of the hole.</p> <p>NB: The side of the mineral wool mat covered in aluminium foil is to be placed uppermost, i.e. facing the fan.</p>	
2	<p>Mount and fasten the location brackets in the underside of the base plate by means of the bolts and nuts supplied.</p> <p>Please notice that the bolt is to be inserted from beneath.</p>	
3	<p>Adjust the distance between the location brackets to fit the inside diameter of the chimney, and then tighten the nuts. Note that there should be a 2-4 mm gap between the brackets and the chimney so as to avoid transmitting vibrations from the fan to the chimney.</p> <p>A and B measurements - please refer to step 1.</p>	

Before fitting onto a steel chimney

Step	Action	
1	A flange (C) is used, fitted so that the spigot end sits inside the chimney (D).	
2	Place the mineral wool mat (A) on the flange (C) with aluminium foil facing upwards and cut a hole in the mineral wool mat, the hole being the same diameter as the flange hole.	
3	Cut the corners of the mineral wool mat, so there is room to fit the vibration dampers (B). If a temperature sensor is to be installed with the chimney fan, cut the aluminium foil on the mineral wool mat to make room for the sensor; this also ensures that the mat sits level on the chimney.	
4	Fit the flange to the chimney fan, with the use of vibration dampers supplied with the flange.	
5	The fan can now be fitted onto the chimney.	

Fitting the chimney fan onto the chimney

Step	Action	
1	The chimney fan is now ready for mounting. Place the glass fibre mat on top of the chimney, the aluminium foil facing upwards, and place the chimney fan on top of the mat.	

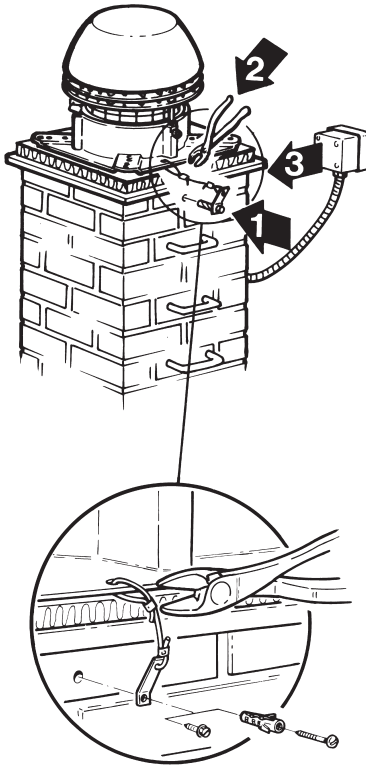
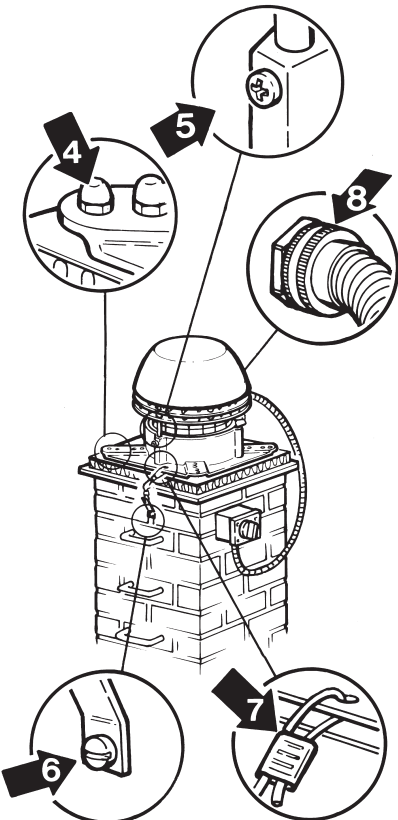
Step	Action	
2	<p>Mount the safety wire in the chimney (1). Use the supplied screw and rawl-plug in brick chimney and the self-cutting screw in steel chimney. Then mount the wire through the hole in the base plate and into the wire lock.</p> <p>Tighten the safety wire slightly and tighten the wire lock (2), so that the chimney fan is secured when opened for service and cleaning purposes.</p> <p>The isolation switch should be fitted onto the side of the chimney (3), so it is easily accessible when servicing the fan. The armoured cable should be connected into the underside of the isolator and up into the switch via the coupling.</p>	
3	<p>Before starting up, make sure that:</p> <ul style="list-style-type: none"> • the nuts in the location brackets are tightened (4) • the chimney fan is closed and the screw tightened (5) • the safety wire is clamped to the chimney (6) • the safety wire and the wire lock are tightened (7) • the grommet on the armoured cable is fastened (8) • the end-user is aware of the fact that the chimney fan must always be operating when the fireplace/boiler is in use 	

1.3 Wiring

Fan and motor specifications are provided on the fan's type plate. All the single-phased models are adjustable.

Wires are to be connected as per the wiring diagram. For further details, please see guidelines for the **exodraft** control units. All **exodraft** fans require extra safeguards in accordance with power current regulations.

Any lightning conductor connected to the fan must respect current applicable legislation.

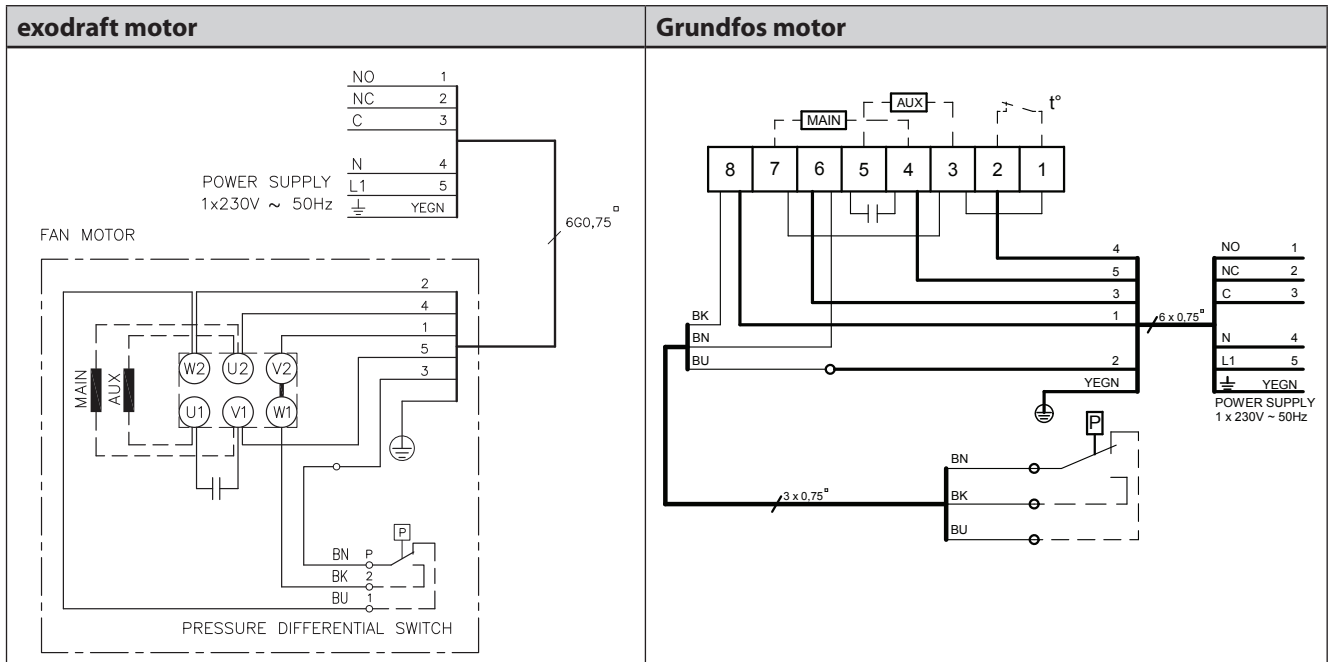

Isolation switch

In accordance with the provisions of the EU Machinery Directive* a chimney fan must always have an isolation switch fitted. The isolation switch must comply with national wiring standards.

The isolation switch must be ordered separately, as it is not part of the standard **exodraft** chimney fan delivery.

*Please refer to Machine Directive (2006/42/EF/-EEC/-EWG/-CEE) - Appendix 1 item 1.6.3 "Separation of the sources of energy."

1.4 Commissioning of the chimney fan

The chimney draught must be checked when commissioning the fan. The pressure differential switch (PDS) might need adjusting during commissioning. The PDS must be set so that the fail-safe system will cut out when the volume of flue gases falls below a set level. During such a test, all windows and doors must be closed and any ventilation fans switched on. Please refer to the relevant **exodraft** Gas Fan Controller Installation Instructions for guidance. As illustrated, remove the top cover and adjust the (PDS) to the required value.

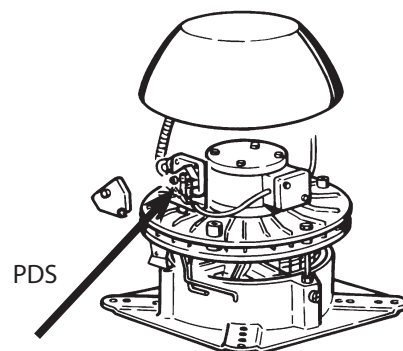

1.5 Service and cleaning

Warning!



• The flow sensors must not be bent or moved, as this might affect their performance.

The motor has special ball bearings that are sealed, lifetime lubricated and maintenance-free. If replacement of the bearings is required, this should be carried out by qualified professionals.

Inspection and cleaning

The fan should be checked and cleaned as required (at least once a year) :

Step	Action	
1	Use the isolation switch to switch off the fan. Wait until the fan stops rotating.	
2	Loosen the screw (A) and open the top section of the fan so that it hangs on its hinges and the safety wire.	
3	Remove any deposits on the vane and the pressure sensors. Test the fail-safe system and check whether it is damaged in any way.	
4	Check the path taken by the smoke through the top and bottom sections of the fan for soot deposits, and clean where necessary with a scraper or brush.	
5	When the fan is open, it is also possible to sweep the chimney.	

Regarding installations in UK:

Gas appliances should be checked for safety once a year by a CORGI registered installer. Details of local installers can be obtained by ringing CORGI on 0870 401 2300 or by accessing the website at www.trustcorgi.com.

1.6 Technical specifications

The sound level is below 67 dB at a distance greater than one metre away from the RSHG fan when it is correctly fitted. Further information is available in the catalogue.

The standard version of the RSHG fan is designed to operate with a maximum flue gas temperature of 250°C. At higher temperatures, though maximum 300 °C, the mineral wool mat should be removed and replaced with optional adjusting screws (type RSD) or vibration dampers (type SVD.-RS) at the flange. See special guidelines for these parts.

1.7 Warranty

exodraft provides a two-year factory warranty on its chimney fans, valid from invoice date. **exodraft** fans must be installed by competent personnel. **exodraft** reserves the right to introduce changes to these guidelines without prior notice.







Declaration of Conformity

DK: EU-Overensstemmelseserklæring GB: Declaration of Conformity DE: EU-Konformitätserklärung FR: Déclaration de conformité de l'Union Européenne NO: EU-Samsvarserklæring	NL: EU-Conformiteits verklaring SE: EU-Överensstämmelsedeklaration FI: EU-Vaatimustenmukaisuusvakuutus IS: ESS-Samræmisstaðfesting IT: Dichiarazione di Conformità Unione Europea
exodraft a/s C.F. Tietgens Boulevard 41 DK-5220 Odense SØ	
-erklærer på eget ansvar, at følgende produkter: -herby declares that the following products: -erklärt hierdurch auf eigene Verantwortung, daß folgende Produkte: -déclare, sous sa propre responsabilité, que les produits suivants: -erklærer på eget ansvar at følgende produkter:	-veklaart dat onderstaande producten: -deklarerar på eget ansvar, att följande produkter: -vastaa siltä, että seuraava tuote: -Staðfesti à eigin àbyrgð, að eftirfarandi vörur: -dichiara con la presente che i seguenti prodotti:
RSHG012, RSHG014	
-som er omfattet af denne erklæring, er i overensstemmelse med følgende standarder: -were manufactured in conformity with the provisions of the following standards: -die von dieser Erklärung umfaßt sind, den folgenden Normen: -auxquels s'applique cette déclaration sont en conformité avec les normes ci-contre: -som er omfattet av denne erklæring, er i samsvar med følgende standarder:	-zijn vervaardigd in overeenstemming met de voorschriften uit de hieronder genoemde normen en standaards: -som omfattas av denna deklaration, överensstämmer m ota tämä selvitys koskee, on seuraavien standardien mukainen: -sem eru meðtalin i staðfestingu Pessari, eru i fullu samræmi við eftirtalda staðla: -sono stati fabbricati in conformità con le norme degli standard seguenti:
EN60335-1, EN60332-2-80, DS/EN ISO 12100-1: 2003, DS/EN ISO 12100-2: 2003	
-i.h.t bestemmelser i direktiv: -in accordance with -entsprechen gemäß den Bestimmungen der folgenden Richtlinien: -suivant les dispositions prévues aux directives: -i.h.t bestemmelser i direktiv:	-en voldoen aan de volgende richtlijnen: -enligt bestämmelserna i följande direktiv: -seuraavien direktiivien määärysten mukaan: -med tilvisun til àkvarðana eftirlits: -in conformità con le direttive:
-Maskindirektivet: -the Machinery Directive: -Richtlinie Maschinen: -Directive Machines: -Maskindirektivet:	-de machinerichtlijn: -Maskindirektivet -Konedirektiivi: -Vèlaeftirlitið: -Direttiva Macchinari:
2006/42/EF/-EEC/-EWG/-CEE	
-Lavspændingsdirektiv: -the Low Voltage Directive: -Niederspannungsrichtlinie: -Directive Basse Tension: -Lavspenningsdirektivet:	-de laagspanningsrichtlijn: -Lågspänningsdirektivet: -Pienjännitedirektiivi: -Smáspennueftirlitið: -Direttiva Basso Voltaggio:
2006/95/EC	
-EMC-direktivet: -and the EMC Directive: -EMV-Richtlinie: -Directive Compatibilité Electromagnétique: -EMC-direktivet:	-en de EMC richtlijn: -EMC-direktivet: -EMC-direktiivi: -EMC-efitirlitið: -Direttiva Compatibilità Elettromagnetica:
2004/108/EC	
Odense, 01.03.2011 -Adm. direktør -Managing Director Jørgen Andersen 	-Algemeen directeur -Geschäftsführender Direktor -Président Directeur Général -Verkställande direktör -Toimitusjohtaja -Framkvemdastjóri -Direttore Generale



DK: exodraft

C. F. Tietgens Boulevard 41
DK-5220 Odense SØ
Tel: +45 7010 2234
Fax: +45 7010 2235
info@exodraft.dk
www.exodraft.dk

SE: exodraft

Årnäsvägen 25B
SE-432 96 Åskloster
Tlf: +46 (0)8-5000 1520
Fax: +46 (0)340-62 64 42
info@exodraft.se
www.exodraft.se

NO: exodraft

Fjordgløttveien 11
NO-3060 Svelvik
Tel: +47 3329 7062
Fax: +47 3378 4110
info@exodraft.no
www.exodraft.no

UK: exodraft

Unit 3, Lancaster Ct.
Cressex Business Park
GB-High Wycombe HP12 3TD
Tel: +44 (0)1494 465 166
Fax: +44 (0)1494 465 163
info@exodraft.co.uk
www.exodraft.co.uk

FR: exodraft

70, avenue de Clichy
75017 Paris
Tél. : +33 (0) 1 44 90 88 90
info@exodraft.fr
www.exodraft.fr

DE: exodraft

Niederlassung Deutschland
Rosengartenstr. 9
DE-55569 Monzingen
Tel: +49 (0)6751 855 599-0
Fax: +49 (0)6751 855 599-9
info@exodraft.de
www.exodraft.de